

# Polebox Compact

## Monteringsanvisning

### Innan montering:

Vi rekommenderar att Polebox Compact förbereds och görs klar med laddboxar innan installationen på fältet

## 1 Kabeldragning

1. Bygla mellan jordplintarna.
2. Dra kabel från plint till jordpunkt. Skruva på mutter och låsbricka på jordpunkten.
3. Montera eventuella jordfels / personskydds - brytare.
4. Dra kabel från plint till JFB.
5. Dra jordledning mellan komponenthållarens jordpunkt och en av sidorna.
6. Om inte JFB monterats. Koppla in kablarna till laddarna på plintens ovansida. Annars kopplas jordkabel till laddarna direkt på plint, inte till jordpunkterna.
7. Montera lagom långa kablar till laddboxen. Dessa ska räckta till plinten eller eventuella JFB när huven är avlyft från underdelen.
8. Alla kablar buntas fast i komponenthållaren. Huven ska kunna lyftas utan att kablarna hakar i.

1,2

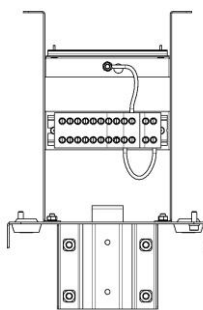

3

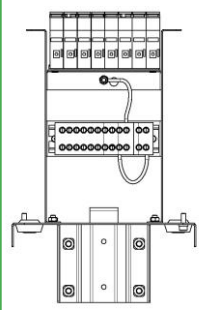

4

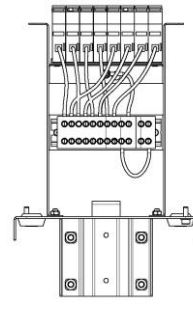

6

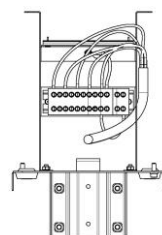

7

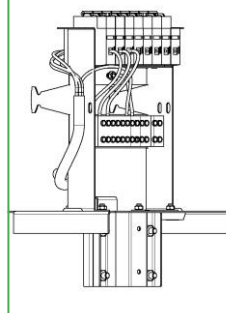

8

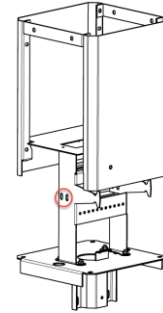

## 2 Stolpmontering

1. Montera överfallet på klämfästet med 4 st M8x20 skruv och brickor. Dra inte åt än
2. Sätt huven på upphaket.
3. Montera Polebox på stolpröret. Håll ordning på inkommande kabel.
4. Rikta in Poleboxen, dra åt klämfästet.
5. Koppla in inkommande kabel på plinten.
6. Lyft ner huven och skruva fast den med 4 st MC6S-M6x16 och brickor.
7. Montera petskyddet.
8. När laddboxarna är testade och fungerar, montera taket.

Tillbehör: Montageplåtar med skruv beställs separat.

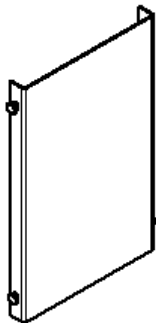

E-nr: 27 004 50 – täckplåt  
Blank (utan hål)

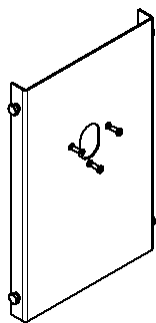

E-nr: 27 004 13 –  
Montageplåt CA Halo

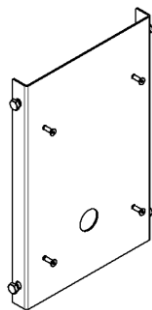

E-nr: 27 004 51 –  
Montageplåt Easee

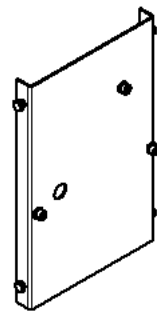

25000303 –  
Montageplåt Commander

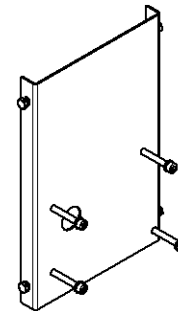

E-nr: 27 004 53 –  
Montageplåt Copper SB

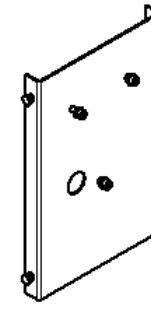

E-nr: 27 004 52 –  
Montageplåt WB Pulsar

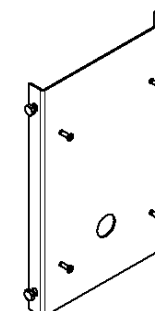

25000306 – Zaptec-Go

# Polebox Compact

## Assembly instructions

### Preparing the installation

It is our recommendation the Polebox is assembled and as ready as possible before the installation on site.



Next Green AB  
Brudtallsvägen 14  
792 32 MORA

www.nextgreen.se  
info@nextgreen.se  
Tel: +46 250 50 39 90

## 1 Cable connection

1. Connect the component holders earth point to one of the sides.
2. Connect PE blocks with a proper wire.
3. When using RCCB/RCBO connect PE from the chargers direct to the PE block.
4. Connect them to the distribution block.
5. Connect the component holders earth point to one of the sides.
6. If no RCCB/RCBO is used, connect the chargers direct to the distribution block.
7. Use cables/wires with proper length. The cables/wires has to be long enough so the sides can be lifted up on the hooks during the mount on the pole.
8. All wires/cables must be secured with cable ties to the component holder and the sides must be able to be lifted up and hooked.

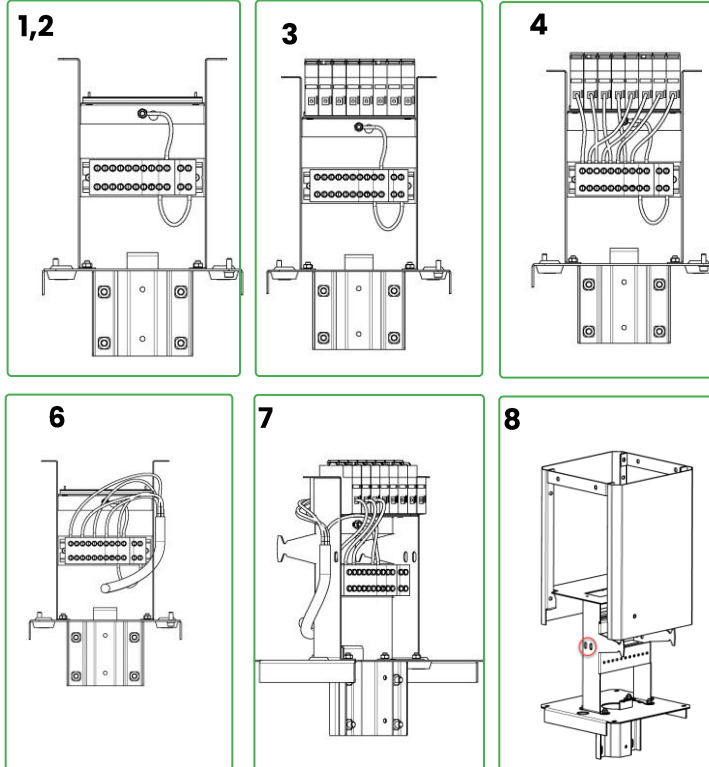

## 2 Pole mounting

1. Mount the clamp with M8x20 screws and washers. Do not tighten yet.
2. Put the sides on the bottom parts hooks.
3. Place the unit on top of the pole. Be careful with incoming cable.
4. Adjust the direction, tighten the clamp.
5. Connect the incoming cable to the distribution block.
6. Lower the sides and fasten it with 4 MC6S-M6x16 and washers.
7. Mount the cover. Use the sheet metal screws.
8. When the chargers are tested and working properly, mount the roof.

Accessories: Mounting plates. Order separately

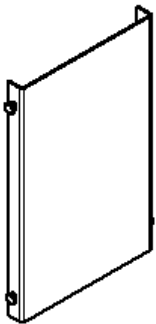

E-nr: 27 004 50 – Täckplåt  
Blank (without wholes)

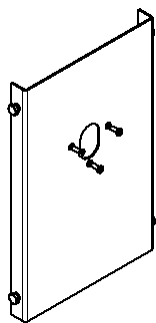

E-nr: 27 004 13 –  
Mounting plate CA Halo

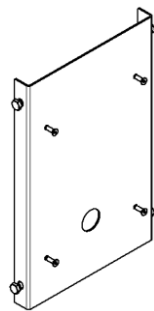

E-nr: 27 004 51 –  
Mounting plate Easee

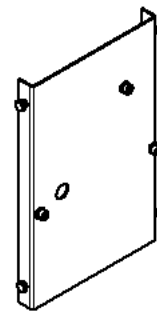

25000303 –  
Mounting plate Commander

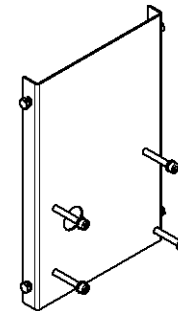

E-nr: 27 004 53 –  
Mounting plate Copper SB

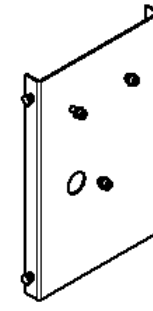

E-nr: 27 004 52 –  
Mounting plate WB Pulsar

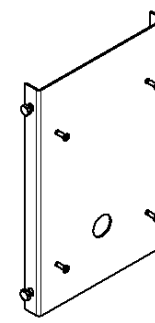

25000306 –  
Mounting plate Zaptec-Go