

# Commander 2: Digital Installation Guide

---

[support.wallbox.com/en/knowledge-base/c2-dig](https://support.wallbox.com/en/knowledge-base/c2-dig)

17 November 2022

## 1. Technical Specifications

---

### General Specifications

---

Colour	White/Black
Cable Length	5 m (7 m optional)
Charging Mode (IEC 61851-1)	Mode 3
Dimensions without cable	221x152x115 mm
Weight without cable	2.4 kg
Operating Temperature	-25 °C to 40 °C (50°C with derating)
Storage Temperature	-40 °C to 70°C
Environmental ratings	IP54, IK10 (High resistance)
Installation location	Indoor and Outdoor use
Mounting Method	Stationary equipment is mounted on the wall. Floor mounting with appropriate Wallbox accessories.
Intended for use	Equipment intended for use by ordinary persons.
Location accesses	Equipment for locations with non-restricted access and restricted access
Product Compliance	CE mark (RED Directive 2014/53/EU and RoHS Directive 2011/65/EU). Main IEC Standards: IEC 61851-1, IEC 61851-21-2, IEC 62196. TR25 Certificate (Singapore)

## Electrical Specifications

Charging Power	3.7 kW (1P)	7.4 kW (1P)	11 kW (3P)	22 kW (3P)
Rated Voltage AC $\pm 10\%$	230 V	230 V	400 V	400 V
Rated Current	16 A	32 A	16 A	32 A
Connector Type (IEC 62196-2)	Type 1 / Type 2	Type 1 / Type 2	Type 2	Type 2
Configurable Current	from 6 A to the rated current			
Rated Frequency	50 Hz / 60 Hz			
Rated diversity factor (RDF)	1			
Rated insulation voltage	1430 Vrms			
Rated impulse withstand voltage	4000 V			
Overvoltage Category	CAT III			
Residual Current Detection	DC 6 mA / AC 30 mA			
External RCCB is required per local regulations.	Type A or Type B			
Protection against electric shock.	CLASS I			
Cable Section	Up to 5 x 10 mm <sup>2</sup>			
EV supply equipment connection:	AEVCS permanently connected to the AC mains supply network			

## 2. Safety Warnings

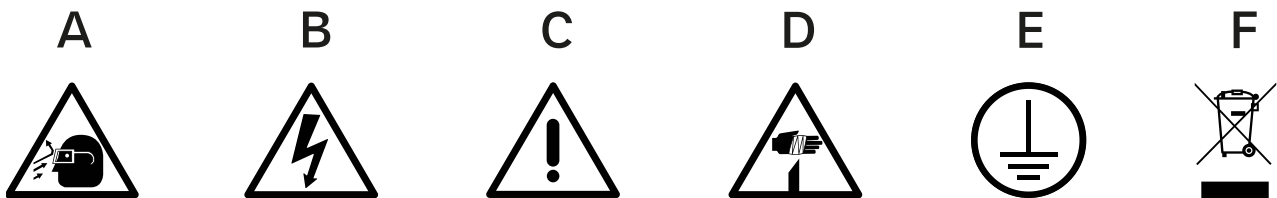

## 3. Tools and Mounting Parts

### Required tools

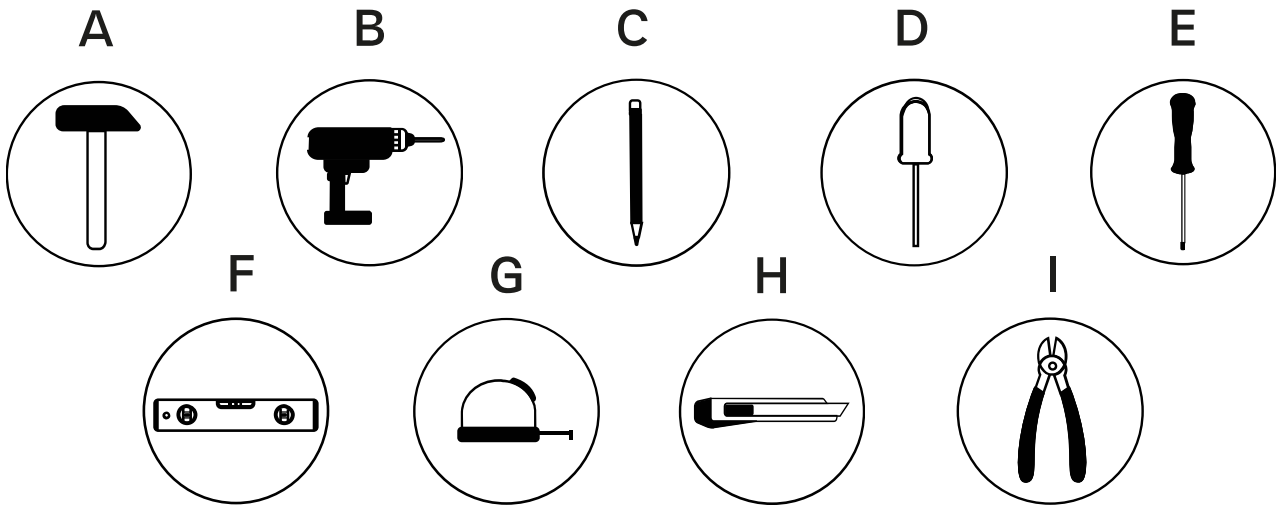

- Hammer
- Electric Drill 8 mm bits
- Pencil
- Phillips Screwdriver
- Torx T9
- Spirit Level
- Measuring Tape
- Utility Knife
- Cutting Pliers

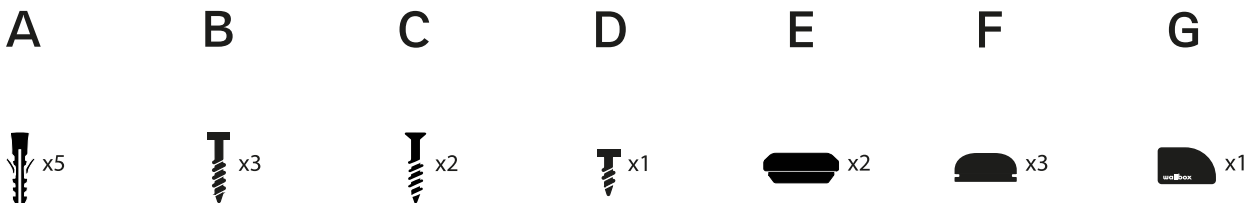

- $\varnothing 8$  x 40 mm wall anchors
- $\varnothing 6$  x 50 mm screws
- $\varnothing 5$  x 40 mm screws
- $\varnothing 3$  x 6 mm screws
- 1-exit M25 grommet
- Protective cap
- Opening tool

## 4. Drilling

Using the drilling template provided, mark three drilling points, then use the drill to complete the procedure and insert the wall anchors.

- ! Do not fix the charger to the wall if you opt for a rear connection. Check section 7 for details on how to fix the charger on the wall in case of a rear connection.

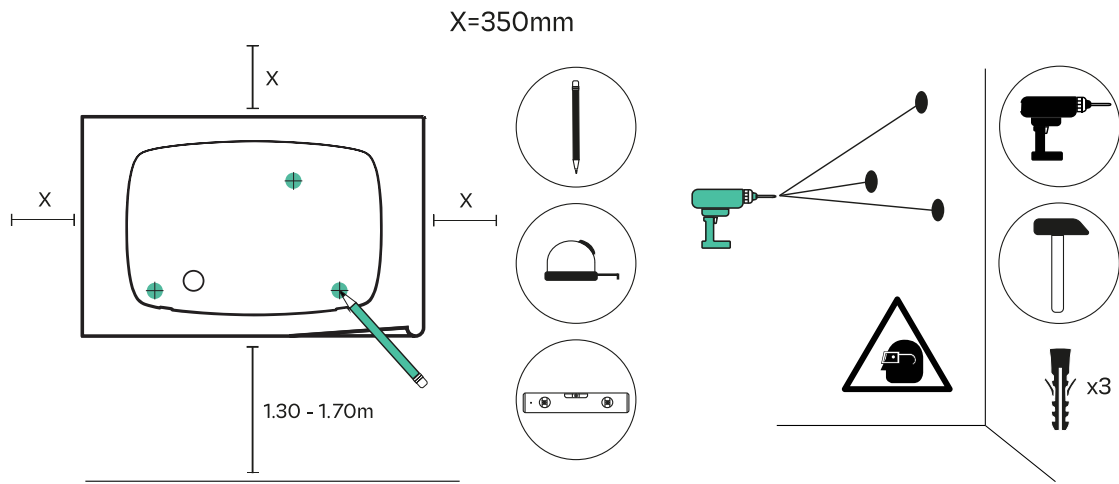

## 5. Lower Connection

- ⚠ Both lower and rear connections are possible when installing Commander 2. Pay attention to the instructions below if you intend to install the product using the bottom hole. For the rear connection, refer to section 6.

Fix the charger to the wall by inserting the screws and the protective caps. Once the charger is fixed to the wall, make an incision on the grommet and pass the supply cable through it.

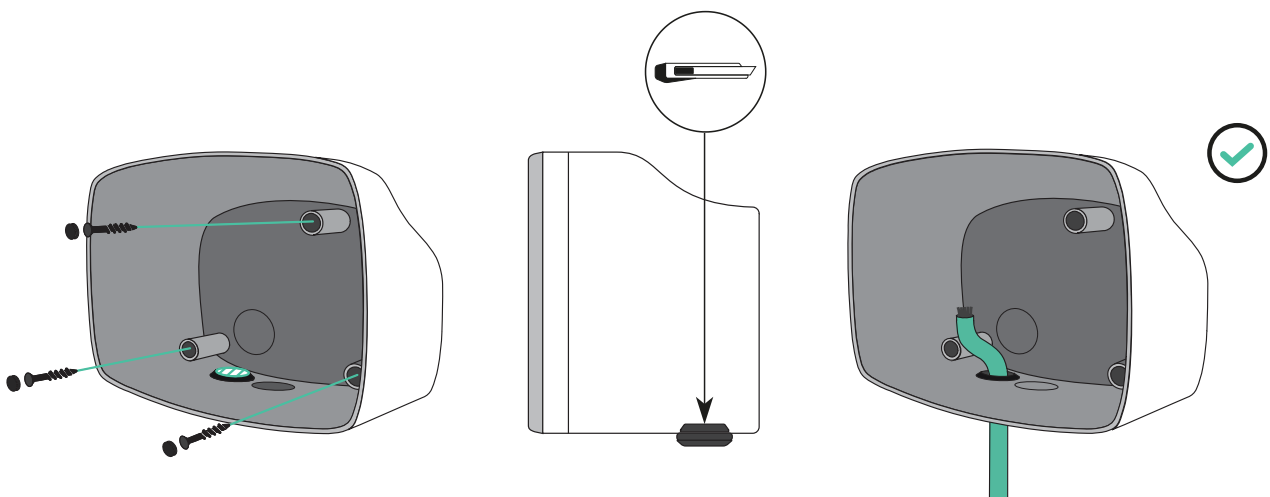

## 6. Rear Connection

Remove the knock-out on the back of the charger and insert the 1-exit grommet. With a utility knife, make an incision on the grommet and pass the cable through it.

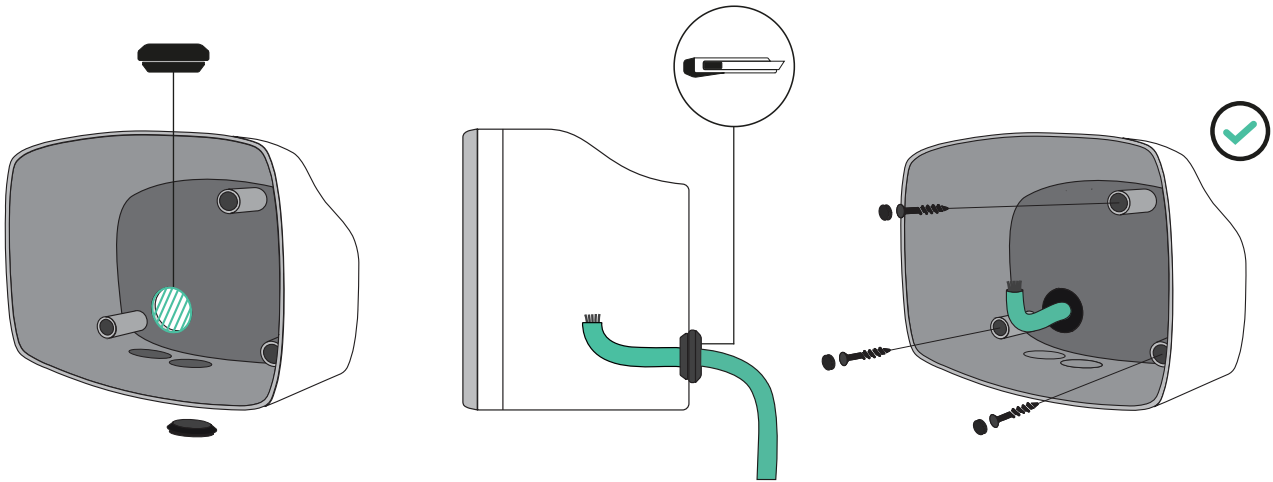

Fix the charger on the wall using the appropriate screws.

**!** Visit the EMS Installation Guide to discover which features are supported by Commander 2.

## 7. Electrical Wiring

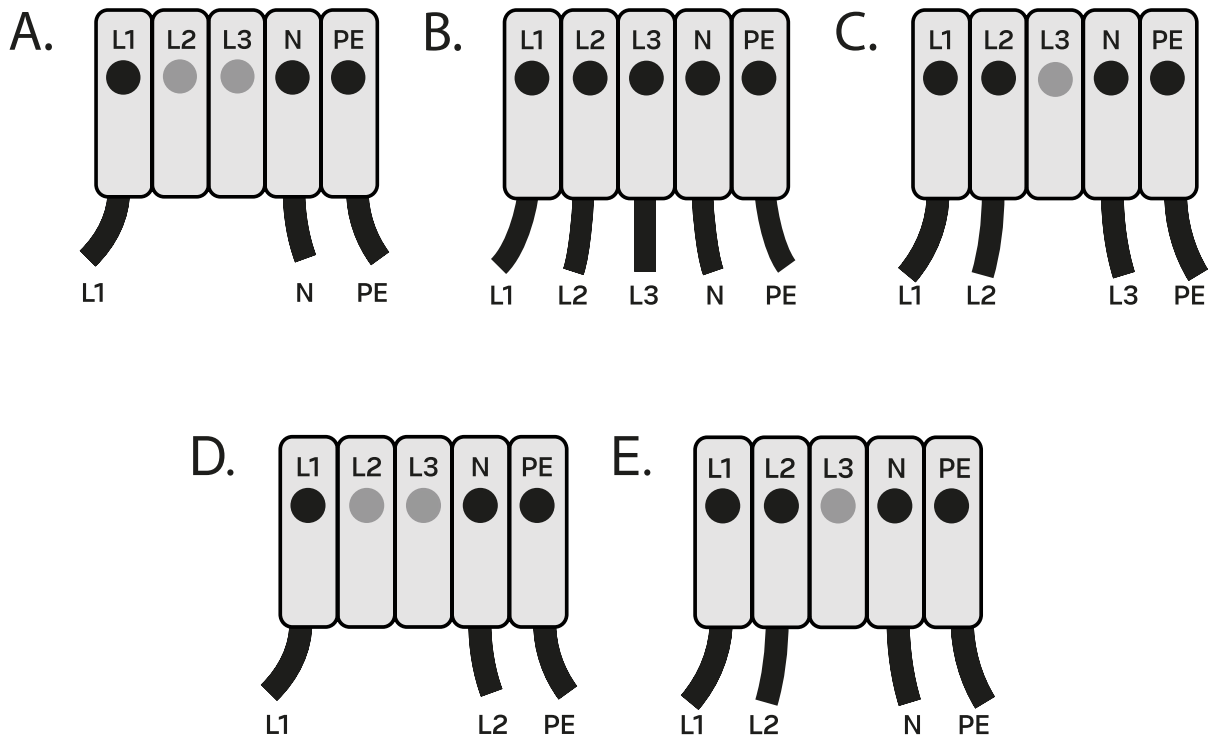

## 8. Plug Holder

Place the plug holder on the wall and mark the fixing points. Then, drill holes in correspondence with the fixing points and insert the anchors.

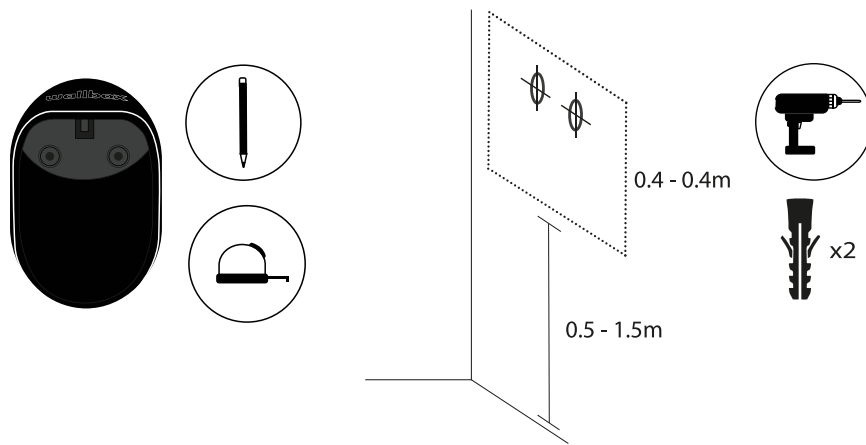

Fix the device to the wall by tightening the screws.

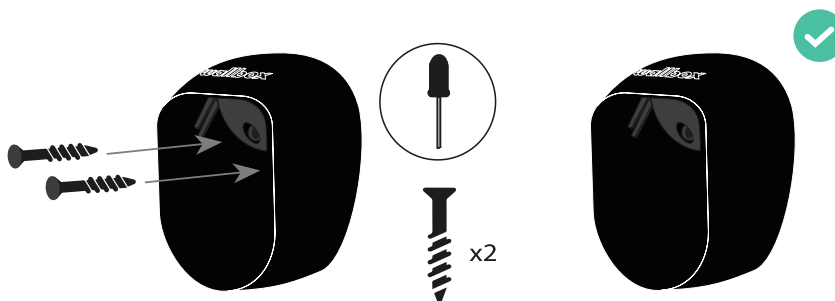

## 9. Connection

There are two connection options when it comes to Commander 2. The charger can be connected through Ethernet or using the 4G dongle.

### Ethernet connection

To connect the charger with the ethernet cable, remove the knock-out next to the power supply input and insert the 3-exit M25 grommet.

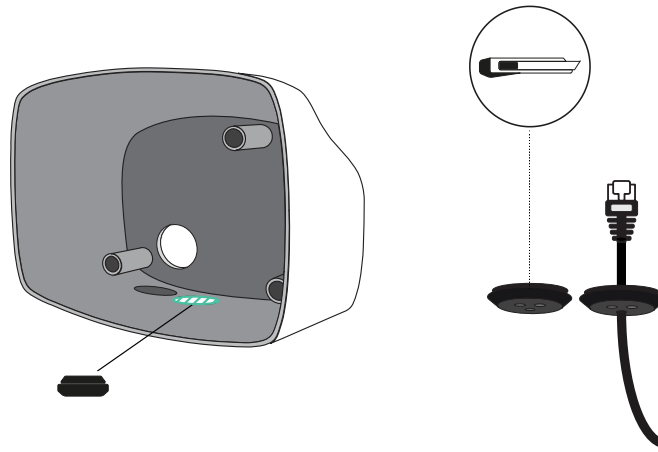

Make an incision in the rubber plug and insert the ethernet cable without the RJ45 connector. Make sure the cable is not too tight and has some clack to facilitate reopening the cover for possible maintenance or servicing. Crimp the RJ45 connector to the cable and connect the cable to the ethernet port in the charger.

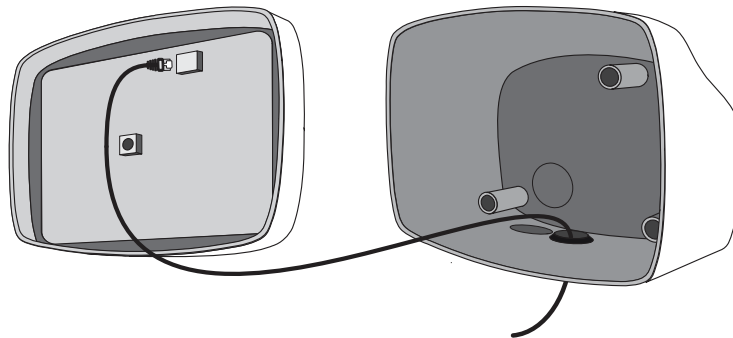

## 4G Connectivity

---

The 4G connectivity is an optional feature that requires an extra accessory. Refer to the Mobile Connectivity Installation Guide available at <https://support.wallbox.com>. Contact your sales agent for more details.

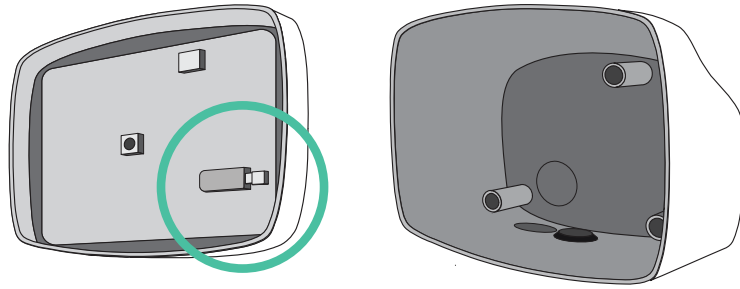

## 10. Closing the Charger

Attach the open end of the communications cable to the connector on the cover. Position the current selector to the appropriate setting according to the electrical installation.

**!** Positions 0, 8, and 9 are reserved for Power Sharing.

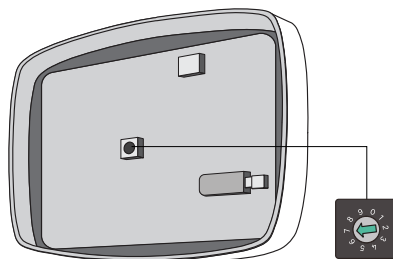

➔	0	1	2	3	4	5	6	7	8	9
i (A)	-	6	10	13	16	20	25	32	-	-

Position the top clip points of the cover on the charger body. Clip the lateral clips to the charger body first and then the bottom clips.

Insert and tighten the Torx screw in the bottom of the charger to secure the front cover.



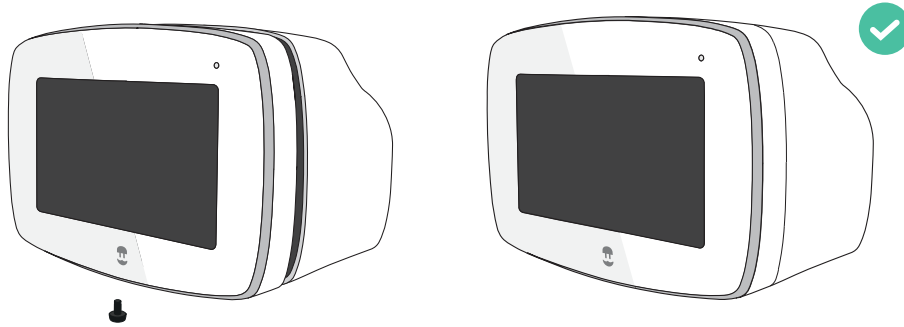

**!** Recommended tightening torque 0.7 Nm +/- 10%

## 11. Registering the Charger

---

Find the Serial Number (SN) and the UID of your charger.

Download the myWallbox App and register. then add your charger by introducing the information requested.



Updated on 15/03/2023

### Was this article helpful?

---

Yes No